

1935 MG R-type
DASO 806

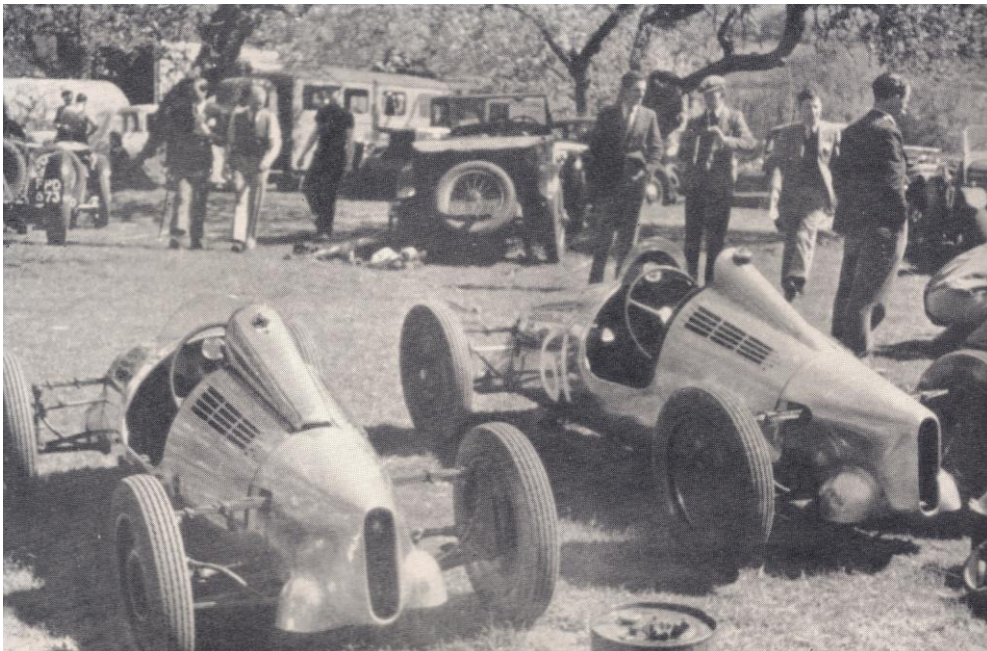

1946 The first two Cooper 500s
DASO 483

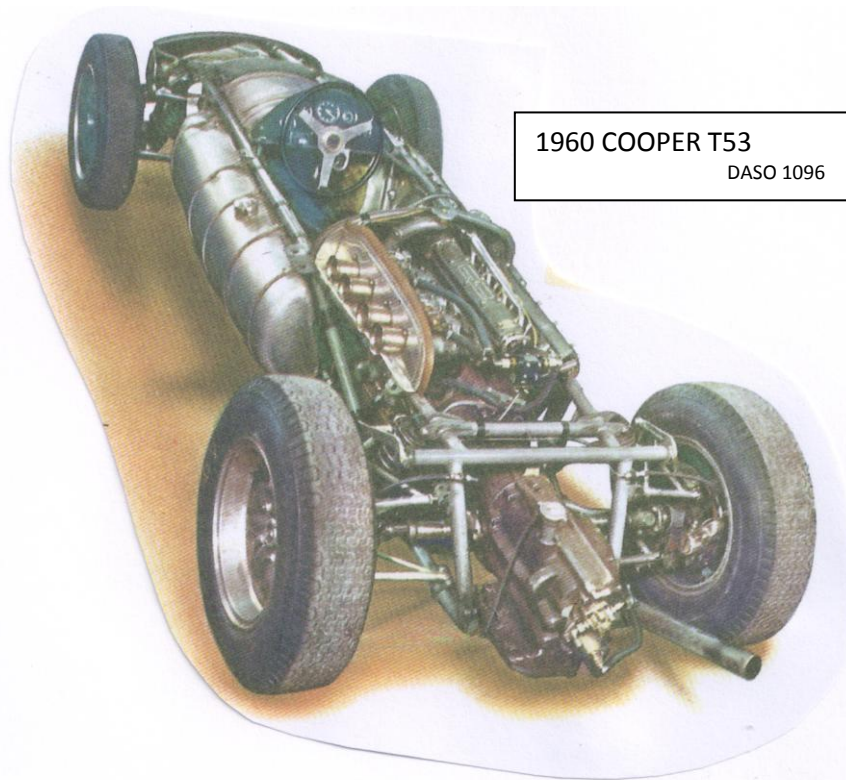

1960 COOPER T53
DASO 1096

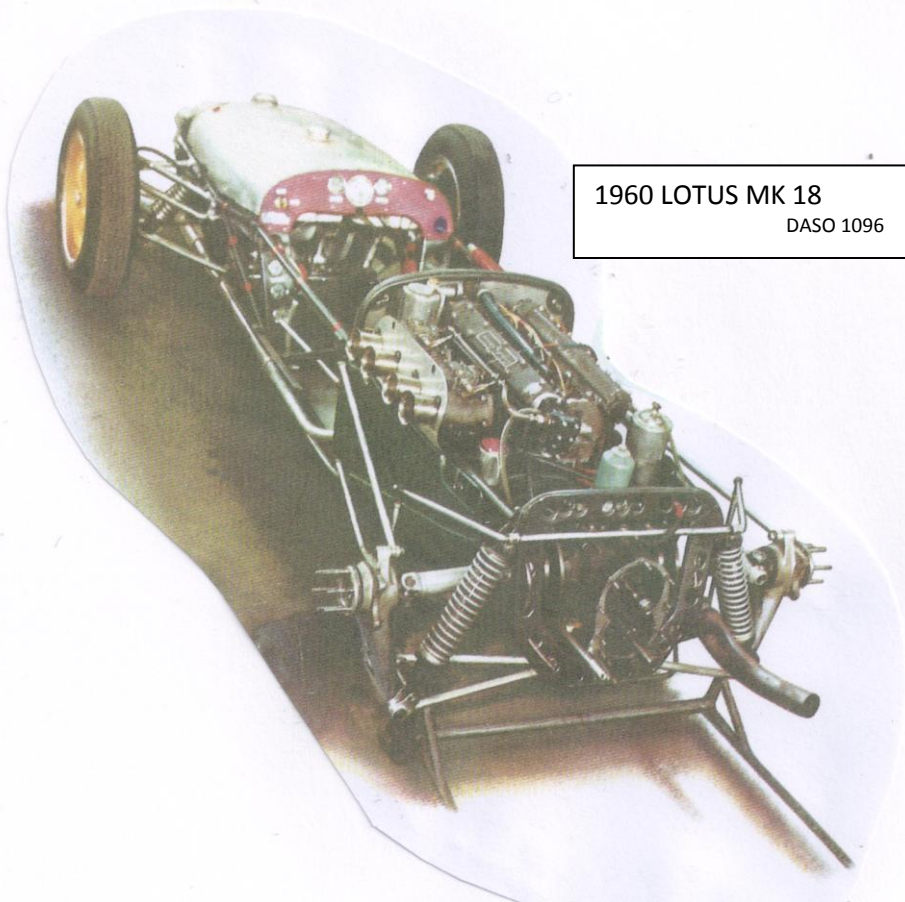

1960 LOTUS MK 18
DASO 1096

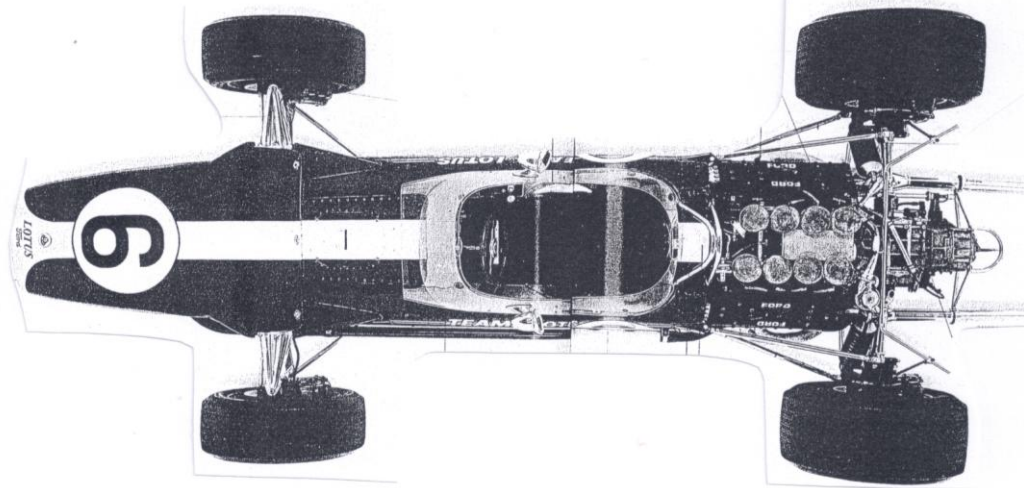

1967 LOTUS MK 49

DASO 964 p.96

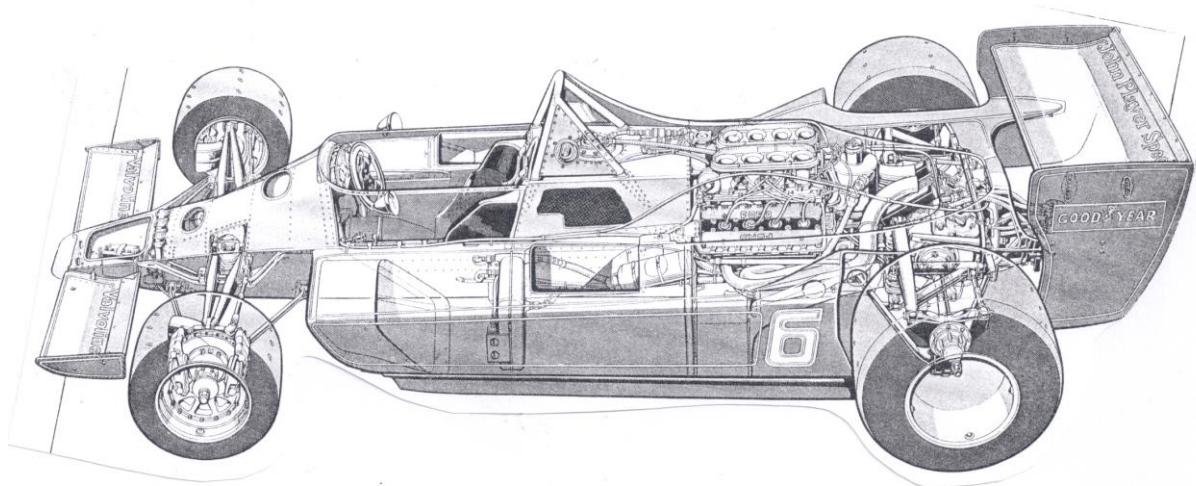

1978 LOTUS MK 79

DASO 961

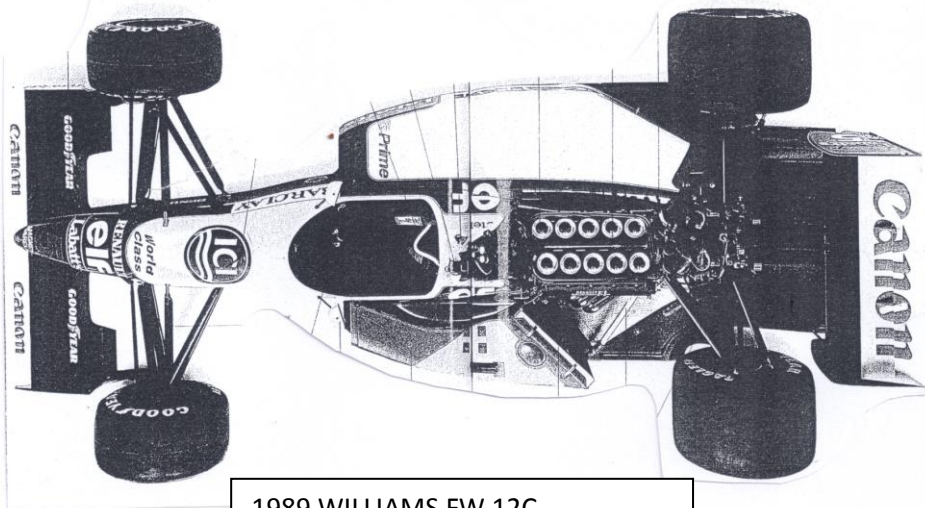

1989 WILLIAMS FW 12C
DASO 964 p. 132

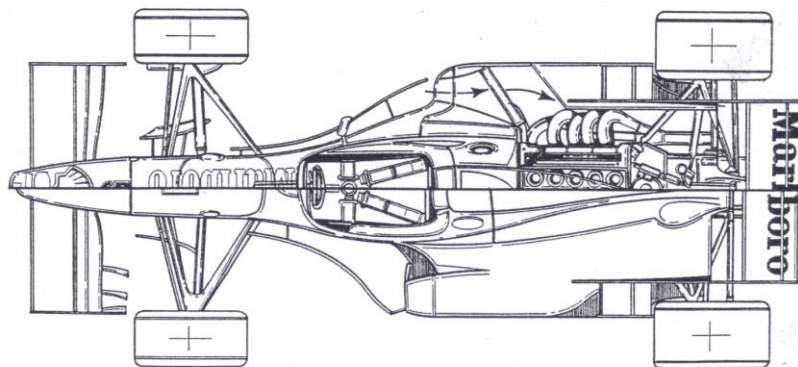

1996 FERRARI F 310 Top ½ plan
1997 FERRARI F 310B Bottom ½ plan
DASO 707

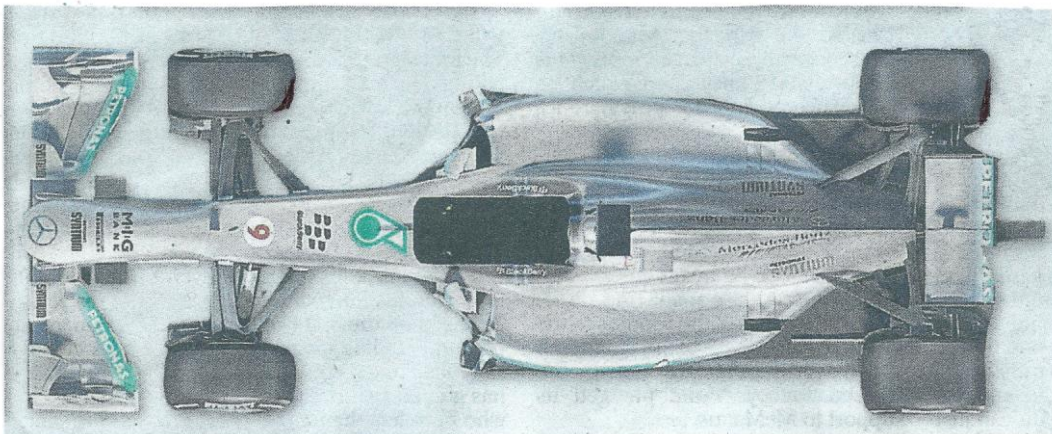

2013 MERCEDES-BENZ
AMG W04
D/Tel 16 March 2013